

# The Giroux correspondence in arbitrary dimensions

Ko Honda

UCLA

March 22, 2024

Joint work with Joseph Breen and Yang Huang

# Goal

Approximately twenty years ago Emmanuel Giroux, in an **extremely influential** paper, formulated/conjectured the equivalence of **contact structures** and **open book decompositions** with Weinstein pages up to stabilization. We give a complete proof of this in arbitrary dimensions using recent developments in convex hypersurface theory.

# 1. Introduction

Let  $(M, \xi)$  be a closed (cooriented) contact manifold of dimension  $2n + 1$ , i.e.,  $\xi = \ker \alpha$  such that  $\alpha \wedge (d\alpha)^n > 0$ .

## Definition

$(M, \xi)$  is *supported by an open book decomposition*  $(B, \pi)$  (abbreviated *OBD*) if

- 1 the *binding*  $B^{2n-1}$  is a codimension 2 (closed) contact submanifold,
- 2  $\pi : M - B \rightarrow S^1$  is a fibration which agrees with the angular coordinate  $\theta$  on a neighborhood  $B \times D^2$  of  $B = B \times \{0\}$ , and
- 3 there exists a Reeb vector field  $R_\alpha$  for  $\xi$  which is everywhere transverse to all the pages  $\pi^{-1}(\theta) \Leftrightarrow$  all the pages  $\pi^{-1}(\theta)$  are Liouville.

# Weinstein and Liouville

## Definition

A *Liouville domain* is a pair  $(W, \lambda)$  consisting of a compact domain  $W^{2n}$  and a 1-form  $\lambda$  such that  $d\lambda$  is symplectic and the Liouville vector field given by  $i_X d\lambda = \lambda$  points transversely out of  $\partial W$  ( $\Rightarrow (\partial W, \lambda|_{\partial W})$  is contact).

# Weinstein and Liouville

## Definition

A *Liouville domain* is a pair  $(W, \lambda)$  consisting of a compact domain  $W^{2n}$  and a 1-form  $\lambda$  such that  $d\lambda$  is symplectic and the Liouville vector field given by  $i_X d\lambda = \lambda$  points transversely out of  $\partial W$  ( $\Rightarrow (\partial W, \lambda|_{\partial W})$  is contact).

## Definition

A Liouville domain  $(W, \lambda)$  is *Weinstein* or *0-Weinstein* (resp. *1-Weinstein*) if its Liouville vector field  $X_\lambda$  is gradient-like for some function  $g : W \rightarrow \mathbb{R}$  which only has Morse type (resp. Morse and birth-death type) critical points.

## Definition

A *supporting OBD* is

- *strongly Weinstein* if all of its pages are 1-Weinstein; and
- *weakly Weinstein* if at least one page is Weinstein.

# OBDs

We can view a Weinstein open book decomposition  $(B, \pi)$  as a relative mapping torus of  $(W, h)$ , where  $W$  is a  $2n$ -dimensional Weinstein domain, obtained as a slight retraction of  $\pi^{-1}(0)$  and  $h \in \text{Symp}(W, \partial W)$ .

# OBDs

We can view a Weinstein open book decomposition  $(B, \pi)$  as a relative mapping torus of  $(W, h)$ , where  $W$  is a  $2n$ -dimensional Weinstein domain, obtained as a slight retraction of  $\pi^{-1}(0)$  and  $h \in \text{Symp}(W, \partial W)$ .

## Definition

A *(positive) stabilization* of  $(W, h)$  is  $(W \cup H, h \circ \tau_L)$ , where:

- 1  $H$  is a Weinstein  $n$ -handle with core Lagrangian disk  $L_1$ ,
- 2 there exists a regular Lagrangian disk  $L_0 \subset W$  with  $\partial L_0 = \partial L_1$  and
- 3  $\tau_L$  is the (positive) Dehn twist about  $L = L_0 \cup L_1$ .



# OBDs

We can view a Weinstein open book decomposition  $(B, \pi)$  as a relative mapping torus of  $(W, h)$ , where  $W$  is a  $2n$ -dimensional Weinstein domain, obtained as a slight retraction of  $\pi^{-1}(0)$  and  $h \in \text{Symp}(W, \partial W)$ .

## Definition

A *(positive) stabilization* of  $(W, h)$  is  $(W \cup H, h \circ \tau_L)$ , where:

- 1  $H$  is a Weinstein  $n$ -handle with core Lagrangian disk  $L_1$ ,
- 2 there exists a regular Lagrangian disk  $L_0 \subset W$  with  $\partial L_0 = \partial L_1$  and
- 3  $\tau_L$  is the (positive) Dehn twist about  $L = L_0 \cup L_1$ .

## Definition

Two strong/weak Weinstein OBDs of  $(M, \xi)$  are *strongly/weakly stably equivalent* if they are related by a sequence of stabilizations and destabilizations, conjugations, and strong/weak Weinstein homotopies.

# Main result

The goal of today's talk is to explain some ingredients of:

## Theorem A

- 1 *Any  $(M, \xi)$  is supported by a strongly Weinstein OBD.*
- 2 *([BHH]) Any two strongly Weinstein OBDs of  $(M, \xi)$  are strongly stably equivalent.*

# Main result

The goal of today's talk is to explain some ingredients of:

## Theorem A

- 1 *Any  $(M, \xi)$  is supported by a strongly Weinstein OBD.*
- 2 *([BHH]) Any two strongly Weinstein OBDs of  $(M, \xi)$  are strongly stably equivalent.*

It was already known by Giroux and Giroux-Mohsen that:

## Theorem (Giroux, Giroux-Mohsen)

- 1 *Any  $(M, \xi)$  is supported by a strongly Weinstein OBD.*
- 2 *Any two strongly Weinstein OBDs of  $(M, \xi)$  obtained by the "Donaldson construction" are strongly stably equivalent.*

# Main result

The goal of today's talk is to explain some ingredients of:

## Theorem A

- 1 *Any  $(M, \xi)$  is supported by a strongly Weinstein OBD.*
- 2 *([BHH]) Any two strongly Weinstein OBDs of  $(M, \xi)$  are strongly stably equivalent.*

It was already known by Giroux and Giroux-Mohsen that:

## Theorem (Giroux, Giroux-Mohsen)

- 1 *Any  $(M, \xi)$  is supported by a strongly Weinstein OBD.*
- 2 *Any two strongly Weinstein OBDs of  $(M, \xi)$  obtained by the "Donaldson construction" are strongly stably equivalent.*

## Question

*What about weakly Weinstein OBDs?*

## 2. Some definitions

### Definition

- 1 A closed oriented embedded hypersurface  $\Sigma^{2n} \subset (M^{2n+1}, \xi)$  is **convex** if there exists a contact vector field  $v \pitchfork \Sigma$ .

## 2. Some definitions

### Definition

- 1 A closed oriented embedded hypersurface  $\Sigma^{2n} \subset (M^{2n+1}, \xi)$  is **convex** if there exists a contact vector field  $v \pitchfork \Sigma$ .
- 2 Its **dividing set** is

$$\Gamma = \{x \in \Sigma \mid v(x) \in \xi_x\},$$

*i.e., the set of points where  $\xi \perp \Sigma$ , measured with respect to  $v$ .*

## 2. Some definitions

### Definition

- 1 A closed oriented embedded hypersurface  $\Sigma^{2n} \subset (M^{2n+1}, \xi)$  is **convex** if there exists a contact vector field  $v \pitchfork \Sigma$ .
- 2 Its **dividing set** is

$$\Gamma = \{x \in \Sigma \mid v(x) \in \xi_x\},$$

*i.e., the set of points where  $\xi \perp \Sigma$ , measured with respect to  $v$ .*

One can show that:

- 1  $\Gamma$  is a contact submanifold of dimension  $2n - 1$ ;
- 2 Up to isotopy,  $\Gamma$  is independent of the choice of contact vector field  $v$ ;
- 3  $\Gamma$  divides  $\Sigma$  into alternating positive and negative regions  $R_+(\Gamma)$  and  $R_-(\Gamma)$  which are Liouville with respect to  $\alpha|_{R_{\pm}(\Gamma)}$ , where  $\alpha$  is a contact form for  $\xi$ .

## 2. Some definitions

### Definition

- 1 A closed oriented embedded hypersurface  $\Sigma^{2n} \subset (M^{2n+1}, \xi)$  is **convex** if there exists a contact vector field  $v \pitchfork \Sigma$ .
- 2 Its **dividing set** is

$$\Gamma = \{x \in \Sigma \mid v(x) \in \xi_x\},$$

*i.e., the set of points where  $\xi \perp \Sigma$ , measured with respect to  $v$ .*

One can show that:

- 1  $\Gamma$  is a contact submanifold of dimension  $2n - 1$ ;
- 2 Up to isotopy,  $\Gamma$  is independent of the choice of contact vector field  $v$ ;
- 3  $\Gamma$  divides  $\Sigma$  into alternating positive and negative regions  $R_+(\Gamma)$  and  $R_-(\Gamma)$  which are Liouville with respect to  $\alpha|_{R_{\pm}(\Gamma)}$ , where  $\alpha$  is a contact form for  $\xi$ .

A convex hypersurface  $\Sigma$  is **Weinstein convex** if  $R_{\pm}(\Gamma)$  are Weinstein.



# Definitions

## Definition

The *characteristic foliation*  $\Sigma_\xi$  is a singular line field in  $\xi \cap T\Sigma$  such that  $i_{\Sigma_\xi} d\alpha|_{\xi \cap T\Sigma} = 0$ . If  $\dim M = 3$ , then  $\Sigma_\xi$  is simply  $\xi \cap T\Sigma$ .

## Remark

The Liouville vector fields of  $R_\pm(\Gamma)$  are tangent to  $\Sigma_\xi$ .

### 3. Convex hypersurface theory

#### Theorem B (HH)

*Any closed hypersurface in a contact manifold can be  $C^0$ -approximated by a Weinstein convex one.*

#### Theorem C (HH)

*Let  $\xi$  be a contact structure on  $\Sigma \times [0, 1]$  such that the hypersurfaces  $\Sigma \times \{0, 1\}$  are Weinstein convex. Then, up to a boundary-relative contact isotopy, there exists a finite sequence  $0 < t_1 < \dots < t_N < 1$  such that the following hold:*

- (B1)  $\Sigma \times \{t\}$  is Weinstein convex if  $t \neq t_i$  for any  $1 \leq i \leq N$ .
- (B2) For each  $i$ , there exists a small  $\epsilon > 0$  such that  $\xi$  restricted to  $\Sigma \times [t_i - \epsilon, t_i + \epsilon]$  is contactomorphic to a bypass attachment (i.e., a smoothly canceling pair consisting of a contact  $n$ -handle and a contact  $(n + 1)$ -handle).

## Step 0

Note that singular points of  $\Sigma_\xi$  occur when  $T\Sigma = \pm\xi$ . If the signs agree, then the singular point is positive; otherwise the singular point is negative.

A  $C^\infty$ -generic hypersurface has isolated Morse-type singular points (the set of singular points may be empty).

After a choice of orientation of a vector field directing  $\Sigma_\xi$ , the positive singularities have index  $0, \dots, n$  and the negative singularities have index  $n, \dots, 2n$ .

# Morse and Morse<sup>+</sup> hypersurfaces

## Definition

A hypersurface  $\Sigma$  is *Morse* if  $\Sigma_\xi$  is gradient-like for some Morse function on  $\Sigma$ . It is *Morse<sup>+</sup>* if in addition there are no trajectories of  $\Sigma_\xi$  from a negative singular point of  $\Sigma_\xi$  to a positive one.

# Morse and Morse<sup>+</sup> hypersurfaces

## Definition

A hypersurface  $\Sigma$  is *Morse* if  $\Sigma_\xi$  is gradient-like for some Morse function on  $\Sigma$ . It is *Morse<sup>+</sup>* if in addition there are no trajectories of  $\Sigma_\xi$  from a negative singular point of  $\Sigma_\xi$  to a positive one.

We can also generalize this definition and replace “Morse” by “ $k$ -Morse”. By “ $k$ -Morse” we mean an element of an  $k$ -parameter family of functions  $\Sigma \rightarrow \mathbb{R}$  which is as generic as possible. So 1-Morse means we are allowing birth-death type critical points and 2-Morse means we are additionally allowing swallowtail singularities.

# Morse and Morse<sup>+</sup> hypersurfaces

## Definition

A hypersurface  $\Sigma$  is *Morse* if  $\Sigma_\xi$  is gradient-like for some Morse function on  $\Sigma$ . It is *Morse<sup>+</sup>* if in addition there are no trajectories of  $\Sigma_\xi$  from a negative singular point of  $\Sigma_\xi$  to a positive one.

We can also generalize this definition and replace “Morse” by “ $k$ -Morse”. By “ $k$ -Morse” we mean an element of an  $k$ -parameter family of functions  $\Sigma \rightarrow \mathbb{R}$  which is as generic as possible. So 1-Morse means we are allowing birth-death type critical points and 2-Morse means we are additionally allowing swallowtail singularities.

## Lemma

Any  $k$ -Morse<sup>+</sup> hypersurface  $\Sigma$  is Weinstein convex.

The proof is similar to Giroux’s proof for convex surfaces from 30 years ago.

## Basic idea in dimension 3

We construct a **plug**:

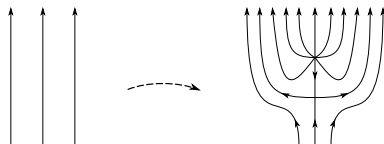

The top one does **NOT** work but the bottom one works and has 4 critical points (one index 0, two index 1, and one index 2). The higher-dimensional plug is much more involved....

## 4. From contact structures to OBDs

### Definition

A *contact handlebody* is a contact manifold contactomorphic to

$$(W \times [-\epsilon, \epsilon], \ker(dt + \lambda)),$$

where  $(W, \lambda)$  is a Weinstein domain and  $t$  is the  $[-\epsilon, \epsilon]$ -coordinate.

A contact handlebody with  $W$  a flexible Weinstein domain is a *flexible contact handlebody*.



# Sketch of CHT proof of existence of OBDs

Given a closed contact manifold  $(M, \xi)$  of dimension  $2n + 1$ , we first choose a self-indexing Morse function  $f : M \rightarrow \mathbb{R}$  so that

$$\Sigma := f^{-1}(n + \frac{1}{2})$$

is a smooth hypersurface which divides  $M$  into two components

$$M - \Sigma = H'_0 \cup H'_1.$$

Using Gromov's  $h$ -principle, we can realize some deformation retraction  $H_i$  of  $H'_i$ ,  $i = 0, 1$ , as a contact handlebody.

## Continuation of proof

### Definition ( $\theta$ -decomposition)

A  $\theta$ -decomposition (aka mushroom burger) of a closed contact manifold  $(M, \xi)$  is a pair consisting of two decompositions  $M = H_0 \cup (\Sigma \times [0, 1]) \cup H_1$  and  $\Delta$ , where:

- 1  $H_0$  and  $H_1$  are contact handlebodies;
- 2  $\partial H_0 \simeq \Sigma \times \{0\}$  and  $\partial H_1 \simeq -\Sigma \times \{1\}$  are Weinstein convex hypersurfaces;
- 3  $\Delta$  is a bypass decomposition of  $(\Sigma \times [0, 1], \xi)$ .

## Continuation of proof

Theorem C implies the existence of a  $\theta$ -decomposition

$$(M = H_0 \cup (\Sigma \times [0, 1]) \cup H_1, \Delta).$$

Since a bypass is a smoothly canceling (but contact-topologically nontrivial) pair of handle attachments of indices  $n$  and  $n + 1$ , a  $\theta$ -decomposition in turn implies the existence of OBDs:

- 1 attach index  $n$  contact handles to  $H_0$  to obtain the contact handlebody  $H'_0$  (think  $W \times [0, 1/2]$ ) and
- 2 attach index  $n + 1$  contact handles to  $H_1$  to obtain the contact handlebody  $H'_1$  (think  $W \times [1/2, 1]$ ).

Details of converting contact Morse functions to open books appear in Sackel.

## 5. Stabilization equivalence

Let  $f_t : M \rightarrow \mathbb{R}$ ,  $t \in [0, 1]$ , be a generic 1-parameter family of smooth functions, where  $f_0$  and  $f_1$  are contact Morse functions corresponding to the two OBDs.

The goal is to try to make each  $f_t$  **as contact as possible** (i.e., realize the analogs of the  $H_i$  at time  $t$  as contact handlebodies and stuff all the nontrivial contact topological data into the  $\Sigma \times [0, 1]$  part). The analysis of such a family  $\{f_t\}$  together with their gradient-like vector fields in smooth topology is classical and is due to Cerf and Hatcher-Wagoner.

## Step 1: 1-parametric version of Theorem C

### Theorem

*Given two sequences of bypass attachments for  $(\Sigma \times [0, 1], \xi)$ , they can be related to each other by two types of moves: far commutativity and adding a trivial bypass.*

## Step 1: 1-parametric version of Theorem C

### Theorem

*Given two sequences of bypass attachments for  $(\Sigma \times [0, 1], \xi)$ , they can be related to each other by two types of moves: far commutativity and adding a trivial bypass.*

### Remark

*This generalizes Bin Tian's thesis in dimension three.*

### Remark

*There is a prototype of this theorem in Giroux's bifurcations paper for  $\dim M = 3$ .*

# 1-parametric version of Theorem C

## Theorem

Let  $\xi_t$ ,  $t \in [0, 1]$ , be a 1-parameter family of contact structures on  $\Sigma \times [0, 1]_s$  such that:

- $\Sigma \times \{0, 1\}$  are Weinstein convex for all  $t \in [0, 1]$ ,
- $\xi_t$  is independent of  $t$  along  $\Sigma \times \{0, 1\}$  and
- Theorem C holds for  $t = 0, 1$ .

Then:

- 1 the characteristic foliations  $\Sigma_{s,t}$  can be made 2-Morse after contact isotopies which leave  $\partial(\Sigma \times [0, 1])$  fixed and
- 2 the stable and unstable submanifolds can be made to intersect as transversely as possible.

# Retrogradient locus

A 2-Morse<sup>+</sup> hypersurface is convex, and so convexity fails only when there is a retrogradient trajectory, i.e., one from a negative singularity to a positive singularity. We make a list of all the possible ways in which we can have retrogradient trajectories. By (2) of the previous theorem, the unstable and stable submanifolds can be made to intersect “as transversely as possible” in a 2-dimensional family.



# Retrogradient locus

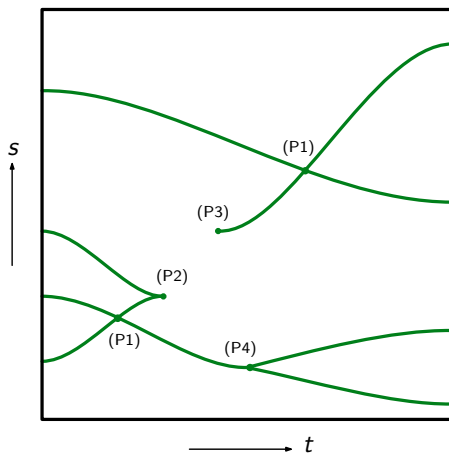

## (P1)–(P4)

- (P1) There are two separate retrogradients from negative nondegenerate index  $n$  singularities to positive nondegenerate index  $n$  singularities.
- (P2) There is a single retrogradient from a negative nondegenerate index  $n$  singularity to a positive nondegenerate index  $n$  singularity, but the respective unstable and stable manifolds are not transverse.
- (P3) There is a single retrogradient from a negative nondegenerate point of index  $n$  to a positive birth-death point of index  $(n - 1, n)$ .
- (P3') There is a single retrogradient from a negative birth-death point of index  $(n, n + 1)$  to a positive nondegenerate point of index  $n$ .
- (P4) There is a single retrogradient from a negative nondegenerate point of index  $n$  to a positive nondegenerate point of index  $n - 1$ .
- (P4') Same as (P4) with  $n \rightsquigarrow n + 1$ .

## What do (P1)–(P4) correspond to?

- (P1) Far commutativity of two bypasses, i.e., we can exchange the order of two bypass attachments. (This does not change the OBD.)
- (P2) No bypass = a certain sequence of two bypasses which is equivalent to a trivial bypass. (A trivial bypass is equivalent to a stabilization.)
- (P3) No bypass = trivial bypass. (Again, a trivial bypass is equivalent to a stabilization.)
- (P4) Two sequences of bypasses are equal to the same single bypass. (This also does not change the OBD.)

## Step 2: Flexible contact handlebodies

In order to be able to “freely” move the skeleta of the contact handlebodies  $H_0, H_1$  of a  $\theta$ -decomposition, we “stabilize”  $H_i \rightsquigarrow H'_i$  to make them flexible.

The basic model is that of a closed Legendrian  $L = S^n$ , its wrinkled stabilization (i.e., with an unfurled swallowtail)  $L'$ , and their “standard” neighborhoods  $N(L') \subset N(L)$ .

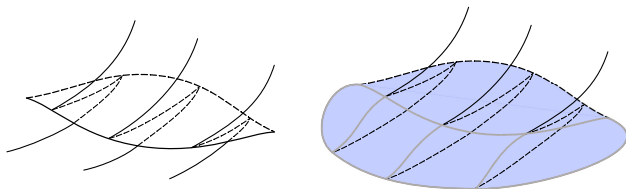
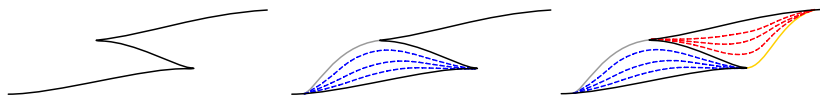

Figure: Unfurled swallowtail (left) and contact  $n$ -handle (right)

# Bypass attachment

To get from  $\Sigma' = \partial N(L')$  to  $\Sigma = \partial N(L)$  we can attach one bypass (one contact  $n$ -handle and a canceling contact  $(n + 1)$ -handle).



**Figure:** The middle depicts attaching a 1-handle (solid gray arc) and a canceling 2-handle (disk foliated by dotted blue arcs) of a bypass to a standard neighborhood of the once-stabilized Legendrian  $L'$  on the left in the  $n = 1$  case.

### Step 3: Canceling pair of index $n, n + 1$ critical points

Suppose  $\exists$  only one bifurcation from  $f_0$  to  $f_1$ , namely a smoothly canceling pair of index  $n, n + 1$  critical points. Here

$$\Theta_0 = H_0 \cup (\Sigma \times [0, 1]) \cup H_1 \quad \text{and} \quad \Theta_1 = H'_0 \cup (\Sigma' \times [0, 1]) \times H'_1.$$

First we  $C^0$ -closely approximate the  $n$ -handle by a (sufficiently) stabilized Legendrian  $L_0$ ; next, viewing the  $n + 1$ -handle upside down, we  $C^0$ -closely approximate it by a stabilized Legendrian  $L_1$ .

## Canceling pair of index $n, n + 1$ critical points, cont'd

There exists an  $(n + 1)$ -dimensional disk  $D_0$  corresponding to the smoothing canceling  $(n + 1)$ -handle such that  $\partial D_0 = L_0 \cup L'_0$ ; similarly  $\exists D_1$  and  $D_0$  and  $D_1$  intersect along an isotropic arc  $\gamma$ .

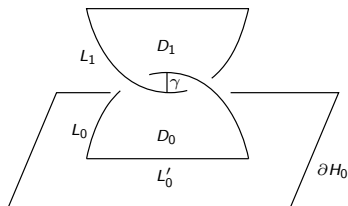

Figure: The “linked” Lagrangian disks  $L_0$  and  $L_1$ .

## Canceling pair of index $n, n + 1$ critical points, cont'd

Let  $H'_0 = H_0 \cup N(L_0)$  and  $H'_1 = H_1 \cup N(L_1)$ .

We compare the bypasses  $\Delta$  needed to go from  $\partial H_0$  to  $\partial H_1$  to the bypasses  $\Delta'$  needed to go from  $\partial H'_0$  to  $\partial H'_1$ .

**Main point:** Go from  $\partial H_0$  to  $\partial H_1$  in a controlled manner so that most of the bypasses of  $\Delta$  have corresponding bypasses in  $\Delta'$ . Then show that the Legendrian  $n$ -skeleton obtained by attaching the  $n$ -handles of  $\Delta$  to  $H_0$  agrees with the  $n$ -skeleton obtained by attaching the  $n$ -handles of  $\Delta'$  of  $H'_0$ .

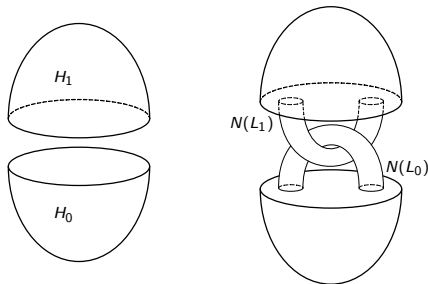



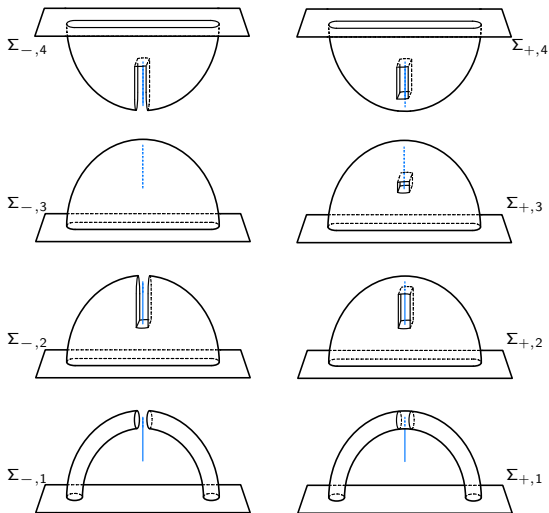

Figure: Some of the hypersurfaces that sweep through  $\Sigma_- \times [0, 1]$  where  $\Sigma_- = \partial H_0$  on the left and the corresponding hypersurfaces for  $\Sigma_+ \times [0, 1]$  where  $\Sigma_+ = \partial H'_0$  on the right. In all figures the light blue arc is  $\gamma$ .